

# EMC TEST REPORT

**Application No.** : TB160312360  
**Applicant** : BIOMEDIS TECHNOLOGIES CO., LIMITED  
**Equipment Under Test (EUT)**  
**EUT Name** : BRIS  
**Model No.** : BRIS-1  
**Series Model No.** : N/A  
**Brand Name** : BRIS  
**Receipt Date** : 2016-03-25  
**Test Date** : 2016-03-25 to 2016-04-11  
**Issue Date** : 2016-04-11  
**Standards** : EN 55014-1:2006+A1:2009+A2:2011  
EN 55014-2:1997+A1:2001+A2:2008  
**Conclusions** : **PASS**

In the configuration tested, the EUT complied with the standards specified above, The EUT technically complies with the 2014/30/EU directive requirements.

**Test/Witness Engineer** :

*Rebecca*

**Approved & Authorized** :

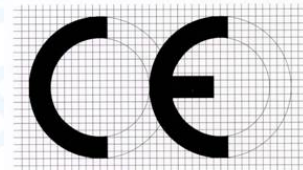
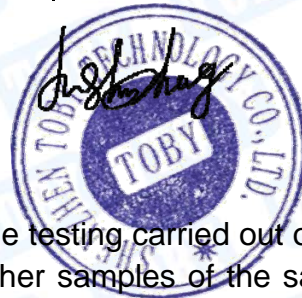

This report details the results of the testing carried out on one sample. The results contained in this test report do not relate to other samples of the same product. The manufacturer should ensure that all products in series production are in conformity with the product sample detailed in the report.

---

---

## TABLE OF CONTENTS

<b>1.</b>	<b>GENERAL INFORMATION.....</b>	<b>3</b>
1.1.	Client Information .....	3
1.2.	General Description of EUT (Equipment Under Test).....	3
1.3.	Block Diagram Showing the Configuration of System Tested .....	3
1.4.	Description of Support Units.....	4
1.5.	Performance Criterion .....	4
1.6.	Classification of Apparatus .....	4
1.7.	Test Facility .....	5
<b>2.</b>	<b>TEST RESULTS SUMMARY .....</b>	<b>6</b>
<b>3.</b>	<b>TEST EQUIPMENT USED .....</b>	<b>7</b>
<b>4.</b>	<b>DISTURBANCE POWER MEASUREMENT .....</b>	<b>8</b>
4.1.	Test Standard and Limit .....	8
4.2.	Test Setup .....	9
4.3.	Test Procedure .....	9
4.4.	Test Condition.....	9
4.5.	Test Data .....	9
<b>5.</b>	<b>RADIATED DISTURBANCE TEST.....</b>	<b>11</b>
5.1.	Test Standard and Limit .....	11
5.2.	Test Setup .....	11
5.3.	Test Procedure .....	11
5.4.	Test Condition.....	12
5.5.	Test Data .....	12
<b>6.</b>	<b>ELECTROSTATIC DISCHARGE IMMUNITY TEST .....</b>	<b>15</b>
6.1.	Test Requirements.....	15
6.2.	Test Setup .....	15
6.3.	Test Procedure .....	15
6.4.	Test Data .....	16
<b>7.</b>	<b>RADIATED ELECTROMAGNETIC FIELD IMMUNITY TEST.....</b>	<b>18</b>
7.1.	Test Requirements.....	18
7.2.	Test Setup .....	18
7.3.	Test Procedure .....	18
7.4.	Test Data .....	19
<b>8.</b>	<b>PHOTOGRAPHS - CONSTRUCTIONAL DETAILS .....</b>	<b>21</b>
<b>9.</b>	<b>PHOTOGRAPHS - TEST SETUP .....</b>	<b>24</b>



## 1. General Information

### 1.1. Client Information

Applicant	:	BIOMEDIS TECHNOLOGIES CO., LIMITED
Address	:	Unit E223, 3/F Wing Tat Comm, Bldg 97 Bonham Strand East, Sheung Wan, Hong Kong
Manufacturer	:	Impermaster Ltd.
Address	:	Bulgaria, gr. Burgas 8000, Burgas Region. Pribojna str 28, ap.6

### 1.2. General Description of EUT (Equipment Under Test)

EUT Name	:	BRIS
Model No.	:	BRIS-1
Series Model No.	:	N/A
Brand Name	:	BRIS
Power Supply	:	DC 5V 500mA
<b>Remark:</b> /		

### 1.3. Block Diagram Showing the Configuration of System Tested

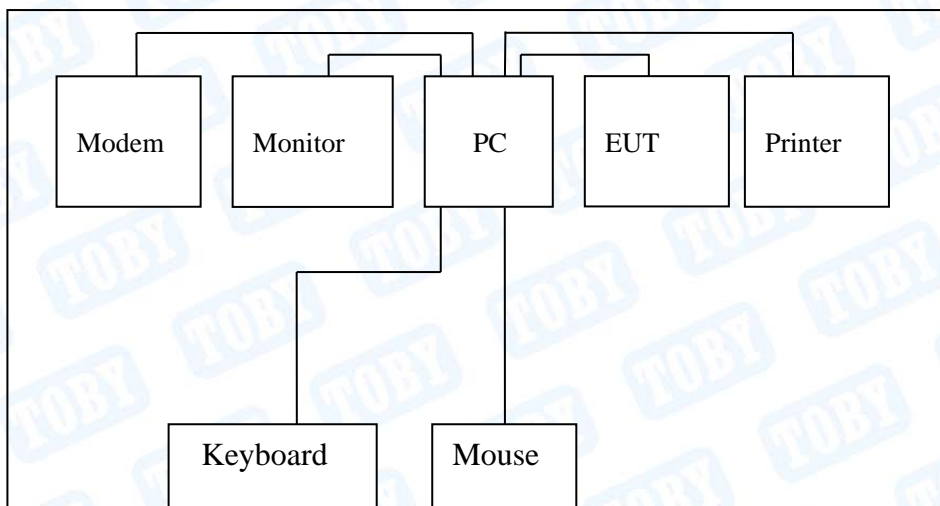

#### 1.4. Description of Support Units

Name	Model	S/N	Manufacturer	Used "√"
Printer	HP1505n	VNF3G06957	HP	√
Modem	RX304Xv2	----	ASUS	√
LCD Monitor	E170Sc	----	DELL	√
PC	OPTIPLEX380	----	DELL	√
Keyboard	L100	U01C	DELL	√
Mouse	M-UARDEL7	----	DELL	√

#### 1.5. Performance Criterion

**Criterion A:** The equipment shall continue to operate as intended without operator intervention. No degradation of performance or loss of function is allowed below a performance level specified by the manufacturer when the equipment is used as intended.

**Criterion B:** After the test, the equipment shall continue to operate as intended without operator intervention. No degradation of performance or loss of function is allowed, after the application of the phenomena below a performance level specified by the manufacturer, when the equipment is used as intended.

**Criterion C:** Loss of function is allowed, provided the function is self-recoverable, or can be restored by the operation of the controls by the user in accordance with the manufacturer's instructions.

#### 1.6. Classification of Apparatus

**Category I:** Apparatus containing no electronic control circuitry.

**Category II:** Transformer toys, dual supply toys, mains powered motor operated appliances, tools, heating appliances and similar electric apparatus (for example-UV radiators, IR radiators and microwave ovens) containing electronic control circuitry with no internal clock frequency or oscillator frequency higher than 15MHz.

**Category III:** Battery powered apparatus (with built-in batteries or external batteries), which in normal use is not connected to the mains, containing an electronic control circuitry with no internal clock frequency or oscillator frequency higher than 15MHz.

This category includes apparatus provided with rechargeable batteries which can be charged by connecting the apparatus to the mains power. However, this apparatus shall also be tested as an apparatus in category III while it is connected to the mains network.

**Category IV:** All other apparatus covered by the scope of this standard.



---

## 1.7. Test Facility

The testing report were performed by the Shenzhen Toby Technology Co., Ltd., in their facilities located at 1A/F., Bldg.6, Yusheng Industrial Zone, The National Road No.107 Xixiang Section 467, Xixiang, Bao'an, Shenzhen, Guangdong, China. At the time of testing, the following bodies accredited the Laboratory:

### **CNAS (L5813)**

The Laboratory has been accredited by CNAS to ISO/IEC 17025: 2005 General Requirements for the Competence of Testing and Calibration Laboratories for the competence in the field of testing. And the Registration No.: CNAS L5813.

### **FCC List No.: (811562)**

The Laboratory is listed in the United States of American Federal Communications Commission (FCC), and the registration number is 811562.

### **IC Registration No.: (11950A-1)**

The Laboratory has been registered by Certification and Engineering Bureau of Industry Canada for radio equipment testing. The site registration: Site# 11950A-1.

## 2. Test Results Summary

<b>EMISSION</b>		
<b>Description of test items</b>	<b>Standards</b>	<b>Results</b>
Conducted disturbance at mains terminals	EN55014-1: 2006+A1: 2009+A2: 2011	N/A
Disturbance Power	EN55014-1: 2006+A1: 2009+A2: 2011	Pass
Click measurement	EN55014-1: 2006+A1: 2009+A2: 2011	N/A
Radiated disturbance	EN55014-1: 2006+A1: 2009+A2: 2011	Pass
Harmonic current emissions	EN61000-3-2: 2014	N/A
Voltage fluctuation and flicker	EN61000-3-3: 2013	N/A
<b>Immunity</b>		
<b>Description of test items</b>	<b>Basic Standards</b>	<b>Results</b>
Electrostatic Discharge (ESD)	EN61000-4-2: 2009	Pass
Radio-frequency, Continuous Radiated Disturbance	EN61000-4-3: 2006+A1: 2008 +A2:2010	Pass
EFT/B Immunity	EN61000-4-4: 2012	N/A
Surge Immunity	EN61000-4-5: 2014	N/A
Conducted RF Immunity	EN61000-4-6: 2014	N/A
Voltage dips, 40% reduction	EN61000-4-11: 2004	N/A
Voltage dips, 70% reduction		
Voltage interruptions		



### 3. Test Equipment Used

Disturbance Power Test					
Equipment	Manufacturer	Model No.	Serial No.	Last Cal.	Cal.Due Date
EMI Test Receiver	Rohde & Schwarz	ESCI	100321	Aug. 07, 2015	Aug. 06, 2016
RF Switching Unit	Compliance Direction Systems Inc	RSU-A4	34403	Aug. 07, 2015	Aug. 06, 2016
Power Clamp	LUTHI	MDS21	3938	Aug. 07, 2015	Aug. 06, 2016
Radiation Emission Test					
Equipment	Manufacturer	Model No.	Serial No.	Last Cal.	Cal.Due Date
Spectrum Analyzer	Agilent	E4407B	MY45106456	Aug. 29, 2015	Aug. 28, 2016
EMI Test Receiver	Rohde & Schwarz	ESCI	101165	Aug. 07, 2015	Aug. 06, 2016
Bilog Antenna	ETS-LINDGREN	3142E	00117537	Mar.26, 2016	Mar. 25, 2017
Bilog Antenna	ETS-LINDGREN	3142E	00117542	Mar.26, 2016	Mar. 25, 2017
Horn Antenna	ETS-LINDGREN	3117	00143207	Mar.26, 2016	Mar. 25, 2017
Horn Antenna	ETS-LINDGREN	3117	00143209	Mar.26, 2016	Mar. 25, 2017
Pre-amplifier	HP	11909A	185903	Mar.26, 2016	Mar. 25, 2017
Pre-amplifier	HP	8447B	3008A00849	Mar.26, 2016	Mar. 25, 2017
Cable	HUBER+SUHNER	100	SUCOFLEX	Mar.26, 2016	Mar. 25, 2017
Signal Generator	Rohde & Schwarz	SML03	IKW682-054	Mar.26, 2016	Mar. 25, 2017
Positioning Controller	ETS-LINDGREN	2090	N/A	N/A	N/A
Discharge Immunity Test					
Equipment	Manufacturer	Model No.	Serial No.	Last Cal.	Cal.Due Date
ESD Generator	HAFELY	PESD 1610	H808671	Mar.19, 2016	Mar.18, 2017
Radiated Immunity Test					
Equipment	Manufacturer	Model No.	Serial No.	Last Cal.	Cal.Due Date
Signal Generator	Rohde & Schwarz	SMT03	200754	Mar.26, 2016	Mar. 25, 2017
Power Meter	Rohde & Schwarz	NRVD	110562	Feb. 16, 2016	Feb. 15, 2017
Voltage Probe	Rohde & Schwarz	URV5-Z2	12056	Feb. 16, 2016	Feb. 15, 2017
Voltage Probe	Rohde & Schwarz	URV5-Z2	12074	Feb. 16, 2016	Feb. 15, 2017
RF Amplifier	AR	50S1G4A	326720	Feb. 16, 2016	Feb. 15, 2017
Bilog Antenna	ETS	3142C	00047662	Feb. 16, 2016	Feb. 15, 2017
Horn Antenna	ARA	DRG-118A	16554	Feb. 16, 2016	Feb. 15, 2017

## 4. Disturbance Power Measurement

### 4.1. Test Standard and Limit

#### 4.1.1. Test Standard

EN55014-1:2006+A1:2009+A2:2011.

#### 4.1.2. Test Limit

Disturbance Power Limits

1	Household and similar appliances		Tools					
	2	3	4	5	6	7	8	9
Frequency range			Rated motor power not exceeding 700W		Rated motor power above 700W and not exceeding 1000W		Rated motor power above 1000W	
(MHz)	dB(pW) Quasi-peak	dB(pW) Average <sup>a</sup>	dB(pW) Quasi-peak	dB(pW) Average <sup>a</sup>	dB(pW) Quasi-peak	dB(pW) Average <sup>a</sup>	dB(pW) Quasi-peak	dB(pW) Average <sup>a</sup>
30 to 300	Increasing linearly with the frequency from:							
	45 to 55	35 to 45	45 to 55	35 to 45	49 to 59	39 to 49	55 to 65	45 to 55
<sup>a</sup> If the limit for the measurement with the average detector is met when using a receiver with a quasi-peak detector, the equipment under test shall be deemed to meet both limits and the measurement using the receiver with an average detector need not be carried out. At the transition frequency the lower limit applies.								

Margin when performing disturbance power measurement

1	Household and similar appliances		Tools					
	2	3	4	5	6	7	8	9
Frequency Range			Rated motor power not exceeding 700W		Rated motor power above 700W and not exceeding 1000W		Rated motor power above 1000W	
(MHz)	dB(pW) Quasi-peak	dB(pW) Average	dB(pW) Quasi-peak	dB(pW) Average	dB(pW) Quasi-peak	dB(pW) Average	dB(pW) Quasi-peak	dB(pW) Average
30 to 300	Increasing linearly with the frequency from							
	0 to 10 dB	-	0 to 10 dB	-	0 to 10 dB	-	0 to 10 dB	-
NOTE 1 This table only applies if specified 4.1.2.3.2. NOTE 2 The measured result at a particular frequency shall be less than the relevant limit minus the corresponding margin (at that frequency)								



## 4.2. Test Setup

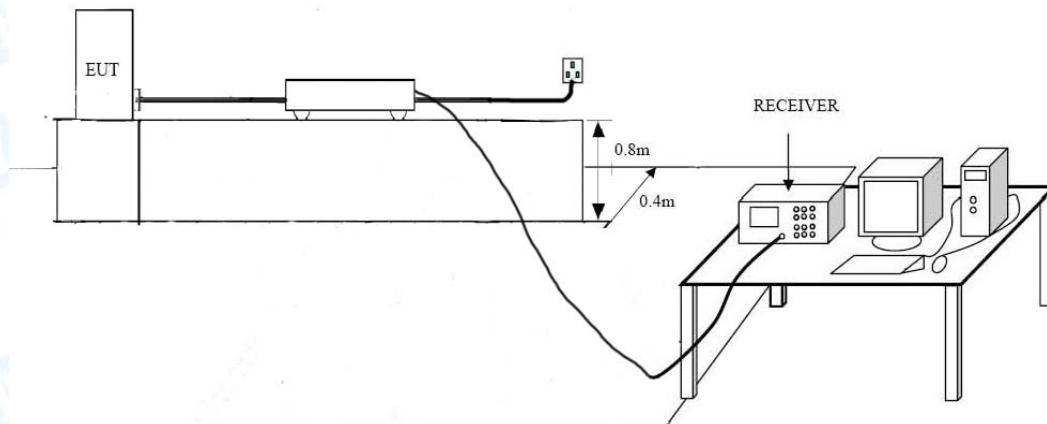

## 4.3. Test Procedure

The EUT is placed on the plane 0.8m high above the ground by insulating support and away from other metallic surface at least 0.4m. It is connected to the power mains through an extension cord of 6m min. The absorber clamp clamps the cord and moves from the far end to the EUT to measure the disturbing energy emitted from the cord.

The bandwidth of the field strength meter is set at 120kHz.

## 4.4. Test Condition

Temperature	:	23 °C
Relative Humidity	:	52 %
Pressure	:	1010 hPa
Test Power	:	DC 5V

## 4.5. Test Data

Please refer to the following pages.

<b>EUT:</b>	BRIS	<b>Model Name :</b>	BRIS-1
<b>Temperature:</b>	25 °C	<b>Relative Humidity:</b>	55%
<b>Test Voltage:</b>	DC 5V		
<b>Terminal</b>	AC Mains		
<b>Test Mode:</b>	Normal Mode		
<b>Remark:</b>			

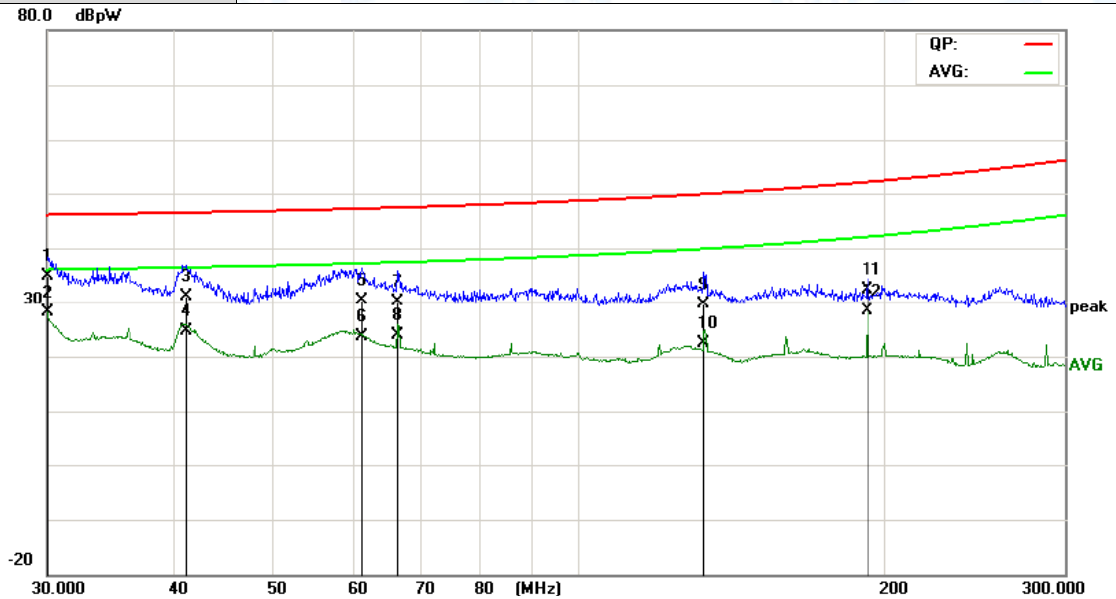

No.	Mk.	Freq. MHz	Reading Level dBpW	Correct Factor dB	Measurement dBpW	Limit dBpW	Over dB	Detector
1		30.0000	-1.60	36.58	34.98	46.00	-11.02	QP
2	*	30.0000	-8.34	36.58	28.24	36.00	-7.76	AVG
3		41.2000	-1.53	32.77	31.24	46.41	-15.17	QP
4		41.2000	-8.06	32.77	24.71	36.41	-11.70	AVG
5		61.0000	-2.69	33.02	30.33	47.15	-16.82	QP
6		61.0000	-9.43	33.02	23.59	37.15	-13.56	AVG
7		66.4400	-1.35	31.59	30.24	47.35	-17.11	QP
8		66.4400	-7.81	31.59	23.78	37.35	-13.57	AVG
9		132.7600	-0.40	30.14	29.74	49.81	-20.07	QP
10		132.7600	-7.82	30.14	22.32	39.81	-17.49	AVG
11		192.0399	2.23	30.14	32.37	52.00	-19.63	QP
12		192.0399	-1.68	30.14	28.46	42.00	-13.54	AVG

**Emission Level= Read Level+ Correct Factor**



## 5. Radiated Disturbance Test

### 5.1. Test Standard and Limit

#### 5.1.1. Test Standard

EN55014-1: 2006+A1: 2009+A2: 2011

#### 5.1.2. Test Limit

Radiated Disturbance Test Limit

Frequency	Limit (Db $\mu$ V/m)
	Quasi-peak Level
30MHz~230MHz	40
230MHz~300MHz	47
300MHz~1000MHz	47

Remark: 1. The lower limit shall apply at the transition frequency.  
2. The test distance is 3m.

### 5.2. Test Setup

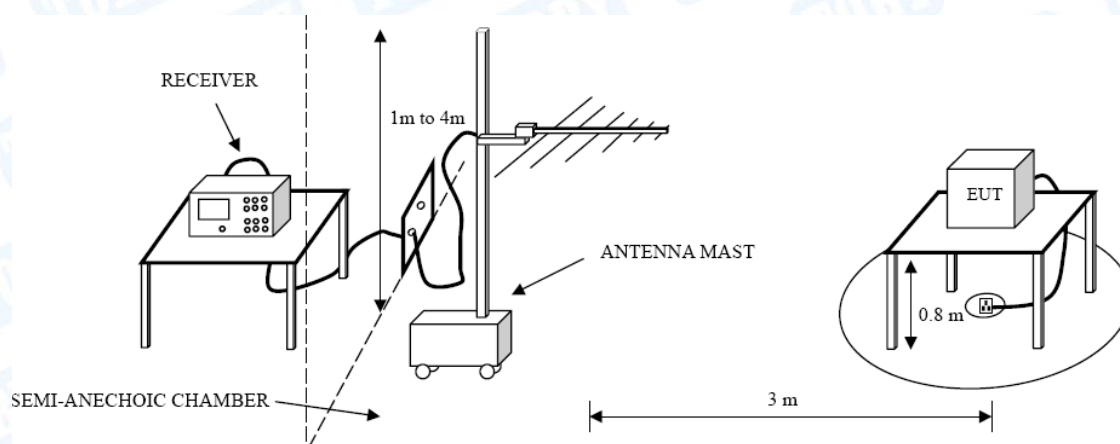

### 5.3. Test Procedure

The EUT was placed on the top of a rotating table 0.8 meters above the ground at a 3m. The table was rotated 360 degrees to determine the position of the highest radiation.

The height of the equipment or of the substitution antenna shall be 0.8 m; the height of the test antenna shall vary between 1 m to 4 m. Both horizontal and vertical polarizations of the antenna are set to make the measurement.

The initial step in collecting radiated emission data is a spectrum Quasi Peak detector mode scanning the measurement frequency range.

If the Peak Mode measured value compliance with and lower than Quasi Peak Mode Limit, the EUT shall be deemed to meet QP Limits and then no additional QP Mode measurement performed.

---

---

#### 5.4. Test Condition

Temperature	:	23 °C
Relative Humidity	:	52 %
Pressure	:	1010 hPa
Test Power	:	DC 5V

#### 5.5. Test Data



<b>EUT:</b>	BRIS	<b>Model Name :</b>	BRIS-1
<b>Temperature:</b>	25 °C	<b>Relative Humidity:</b>	55%
<b>Test Voltage:</b>	DC 5V		
<b>Ant. Pol.</b>	Horizontal		
<b>Test Mode:</b>	Normal Mode		
<b>Remark:</b>			

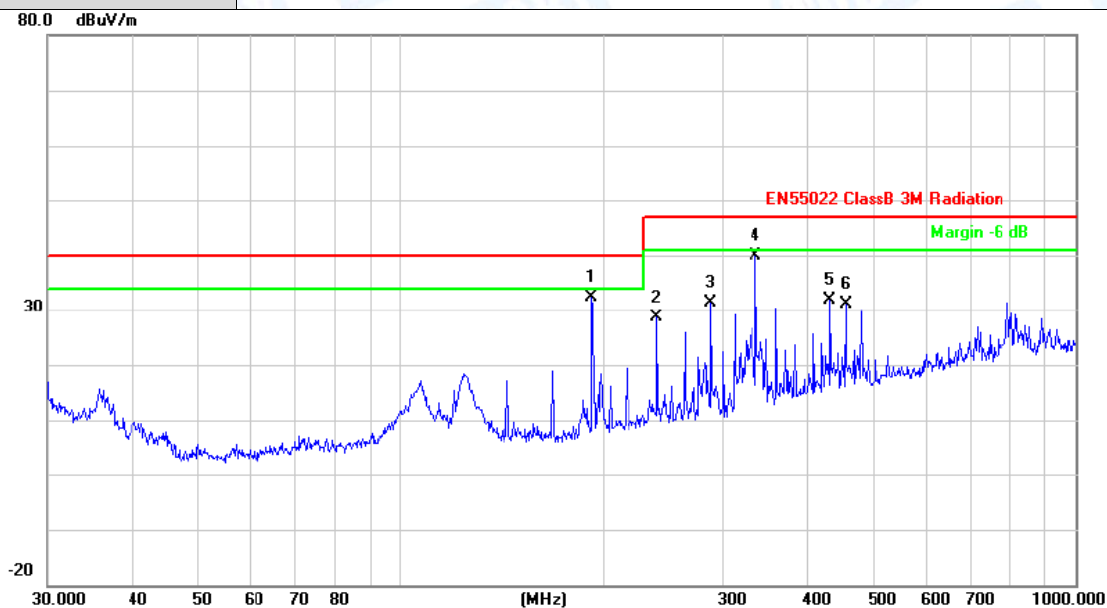

No.	Mk.	Freq. MHz	Reading Level dBuV	Correct Factor dB/m	Measure- ment dBuV/m	Limit dBuV/m	Over dB	Detector
1		191.7450	53.30	-20.81	32.49	40.00	-7.51	peak
2		239.9874	47.12	-18.59	28.53	47.00	-18.47	peak
3		287.9904	48.72	-17.32	31.40	47.00	-15.60	peak
4	*	336.0352	55.30	-15.46	39.84	47.00	-7.16	peak
5		432.5457	44.56	-12.78	31.78	47.00	-15.22	peak
6		455.9058	43.32	-12.26	31.06	47.00	-15.94	peak

**Emission Level= Read Level+ Correct Factor**

<b>EUT:</b>	BRIS	<b>Model Name :</b>	BRIS-1
<b>Temperature:</b>	25 °C	<b>Relative Humidity:</b>	55%
<b>Test Voltage:</b>	DC 5V		
<b>Ant. Pol.</b>	Vertical		
<b>Test Mode:</b>	Normal Mode		
<b>Remark:</b>			

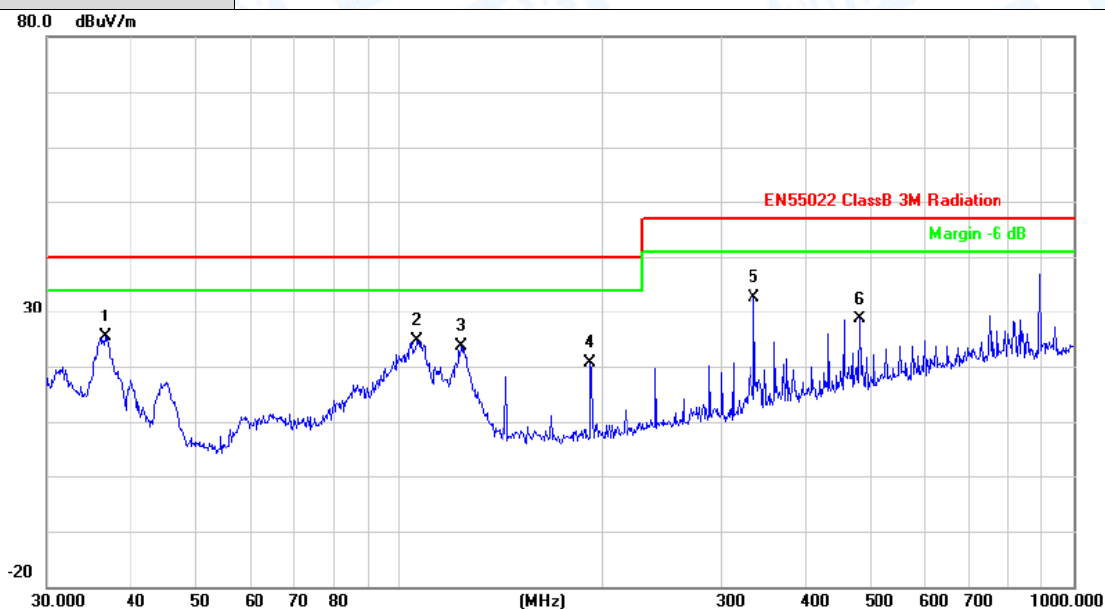

No.	Mk.	Freq. MHz	Reading Level dBuV	Correct Factor dB/m	Measure- ment dBuV/m	Limit dBuV/m	Over dB	Detector
1		36.5092	43.44	-17.99	25.45	40.00	-14.55	peak
2		106.3850	46.44	-21.85	24.59	40.00	-15.41	peak
3		123.2655	45.96	-22.40	23.56	40.00	-16.44	peak
4		191.7450	41.43	-20.81	20.62	40.00	-19.38	peak
5	*	336.0352	48.19	-15.46	32.73	47.00	-14.27	peak
6		480.5276	40.14	-11.62	28.52	47.00	-18.48	peak

**Emission Level= Read Level+ Correct Factor**



## 6. Electrostatic Discharge Immunity Test

### 6.1. Test Requirements

#### 6.1.1. Test Standard

EN55014-2: 1997+A1: 2001+A2: 2008 (EN 61000-4-2:2009)

#### 6.1.2. Test Level

Level	Test Voltage Contact Discharge (KV)	Test Voltage Air Discharge (KV)
1.	±2	±2
2.	±4	±4
3.	±6	±8
4.	±8	±15
X	Special	Special

#### 6.1.3. Performance criterion: B

### 6.2. Test Setup

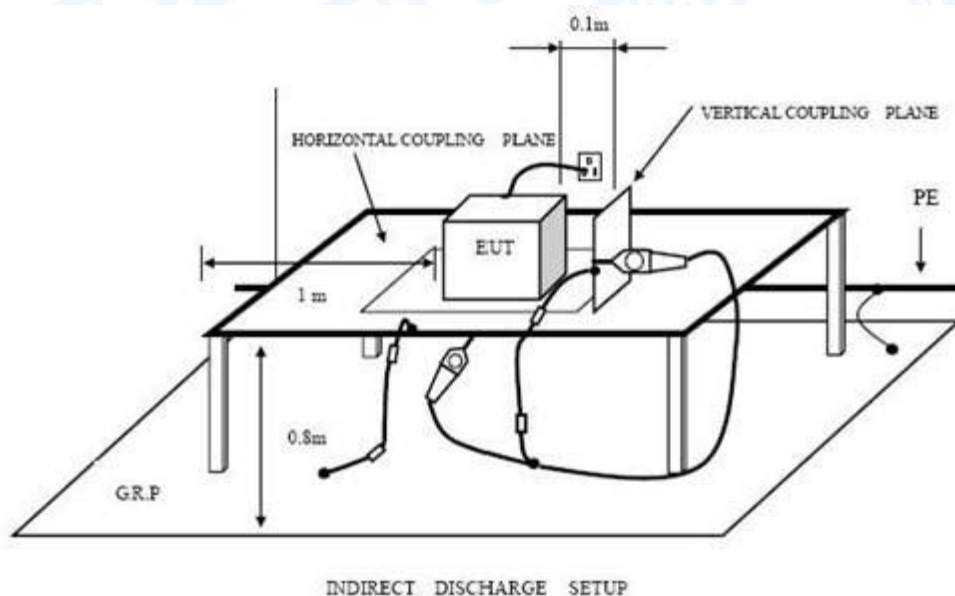

### 6.3. Test Procedure

#### 6.3.1. Air Discharge:

This test is done on a non-conductive surface. The round discharge tip of the discharge electrode shall be approached as fast as possible to touch the EUT. After each discharge, the discharge electrode shall be removed from the EUT. The generator is then re-triggered for a new single discharge and repeated 10 times for each pre-selected test point. This procedure shall be repeated until all the air discharge completed.

---

### 6.3.2. Contact Discharge:

All the procedure shall be same as air discharge. Except that the tip of the discharge electrode shall touch the EUT before the discharge switch is operated.

### 6.3.3. Indirect discharge for horizontal coupling plane

At least 10 single discharges (in the most sensitive polarity) shall be applied at the front edge of each HCP opposite the center point of each unit (if applicable) of the EUT and 0.1m from the front of the EUT. The long axis of the discharge electrode shall be in the plane of the HCP and perpendicular to its front edge during the discharge.

### 6.3.4. Indirect discharge for vertical coupling plane

At least 10 single discharges (in the most sensitive polarity) shall be applied to the center of one vertical edge of the coupling plane. The coupling plane, of dimensions 0.5m X 0.5m, is placed parallel to, and positioned at a distance of 0.1m from the EUT. Discharges shall be applied to the coupling plane, with this plane in sufficient different positions that the four faces of the EUT are completely illuminated.

## 6.4. Test Data

Please refer to the following page.



## Electrostatic Discharge Test Result

EUT : BRIS	M/N : BRIS-1	
Temperature : 23°C	Humidity : 53%	
Power supply : DC 5V	Test Mode : Normal Mode	
Criterion: B		
Air Discharge: ±8Kv Contact Discharge: ±4Kv		
For each point positive 10 times and negative 10 times discharge.		
Location	Kind A-Air Discharge C-Contact Discharge	Result
Nonconductive Enclosure	A	PASS
Slot of EUT	A	PASS
Button	A	PASS
Conductive Enclosure	C	PASS
Port	C	PASS
HCP	C	PASS
VCP of front	C	PASS
VCP of rear	C	PASS
VCP of left	C	PASS
VCP of right	C	PASS

## 7. Radiated Electromagnetic Field Immunity test

### 7.1. Test Requirements

#### 7.1.1. Test Standard

EN55014-2: 1997+A1: 2001+A2: 2008 (EN 61000-4-3:2006+A1:2008+A2:2010)

#### 7.1.2. Test Level

Level	Field Strength V/m
1.	1
2.	3
3.	10
X	Special

#### 7.1.3. Performance criterion: A

### 7.2. Test Setup

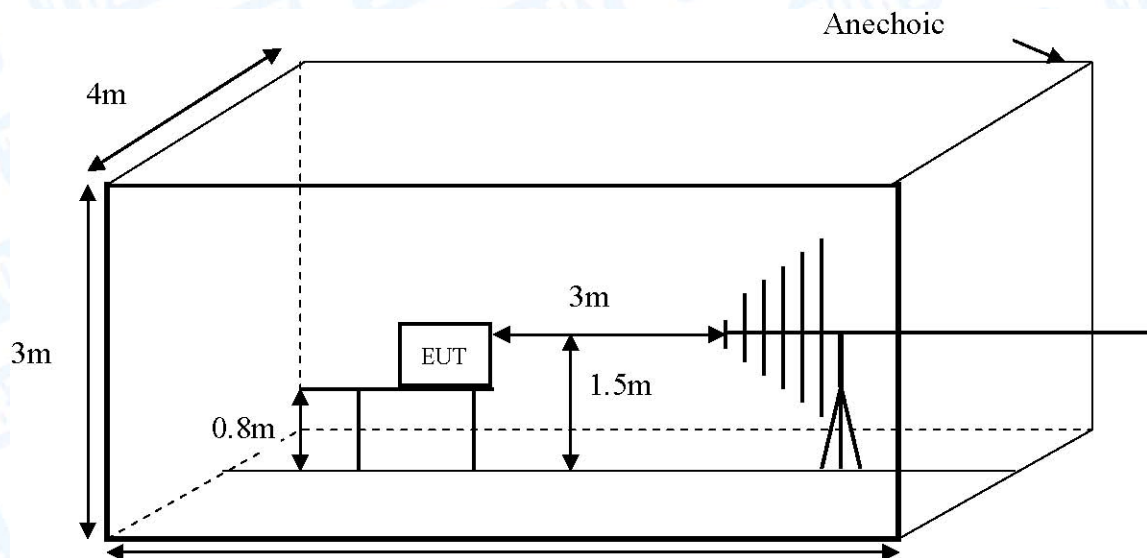

### 7.3. Test Procedure

The EUT are placed on a table, which is 0.8 meter high above the ground. The EUT is set 3 meters away from the transmitting antenna, which is mounted on an antenna tower. Both horizontal and vertical polarization of the antenna is set on test. Each of the four sides of the EUT must be faced this transmitting antenna and measured individually.

In order to judge the EUT performance, a camera is used to monitor its screen.



All the scanning conditions are as following:

Condition of Test	Remark
1. Fielded Strength	3V/m (Severity Level 2)
2. Radiated Signal	Modulated
3. Scanning Frequency	80-1000MHz
4. Sweep time of radiated	0.0015 Decade/s
5. Dwell Time	1 Sec.

#### 7.4. Test Data

Please refer to the following page.

## RF Field Strength Susceptibility Test Results

EUT : BRIS	M/N : BRIS-1			
Temperature : 23°C	Humidity : 53%			
Power supply : DC 5V	Test Mode : Normal Mode			
Criterion: A				
Modulation: Unmodulated				
Pulse: AM 1KHz 80%				
	Frequency Range 1	Frequency Range 2		
	80~1000MHz	/		
	Horizontal	Vertical	Horizontal	Vertical
Front	PASS	PASS	/	/
Right	PASS	PASS	/	/
Rear	PASS	PASS	/	/
Left	PASS	PASS	/	/
<b>Remark:</b>				



## 8. Photographs - Constructional Details

Photo 1 Appearance of EUT



Photo 2 Appearance of EUT

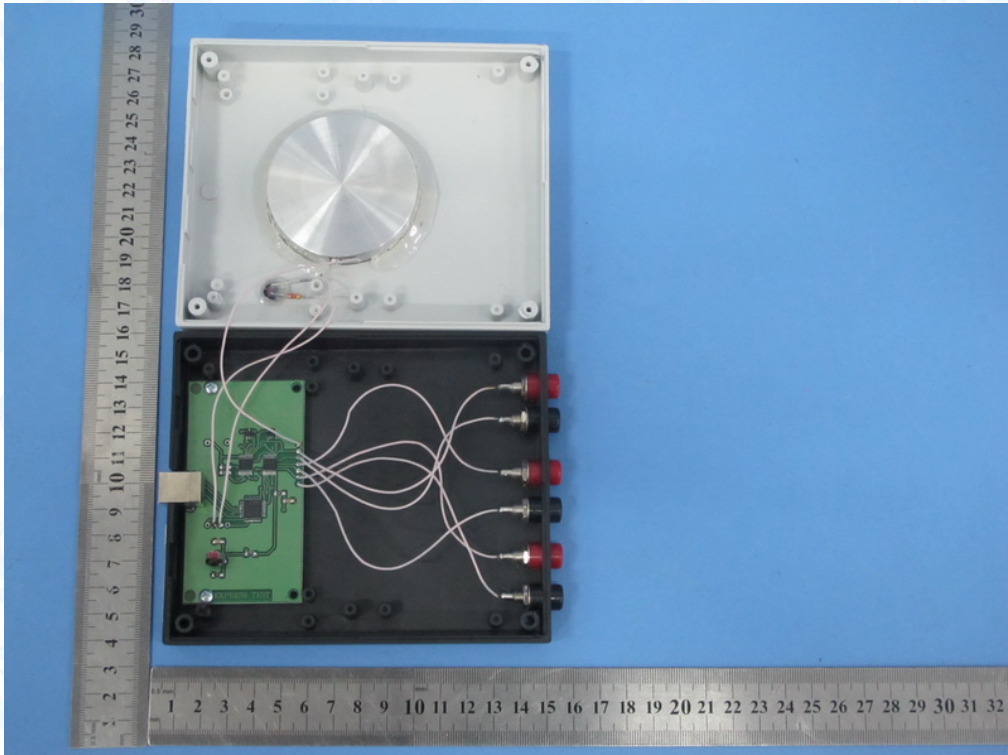



**Photo 3 Appearance of EUT**

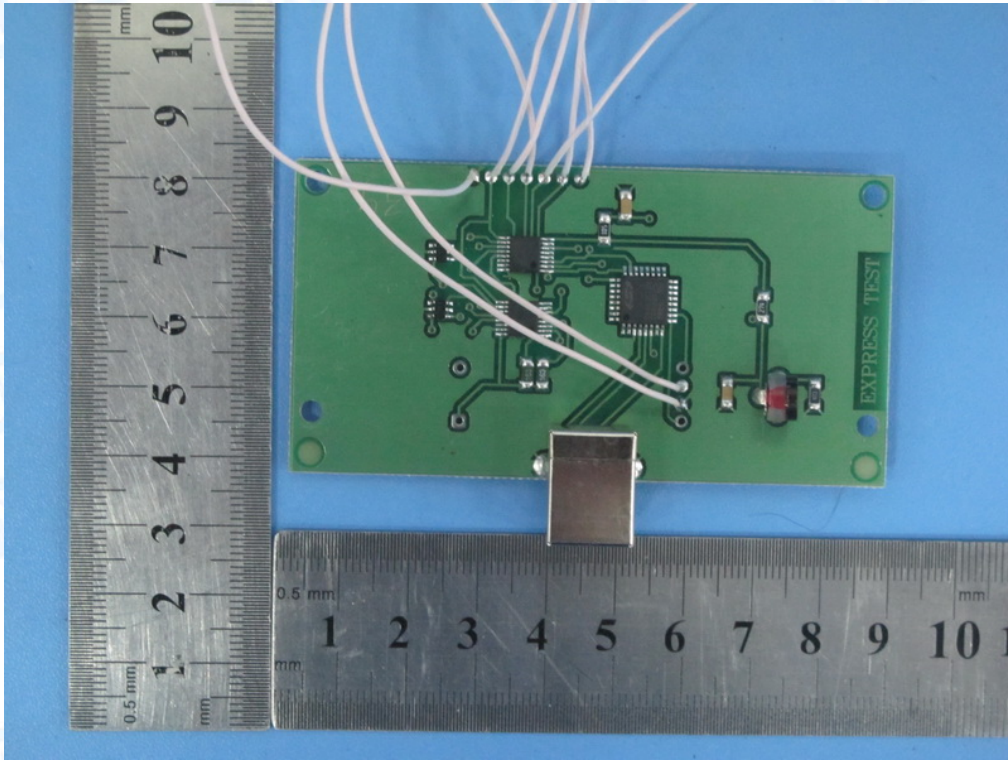

**Photo 4 Internal of EUT**

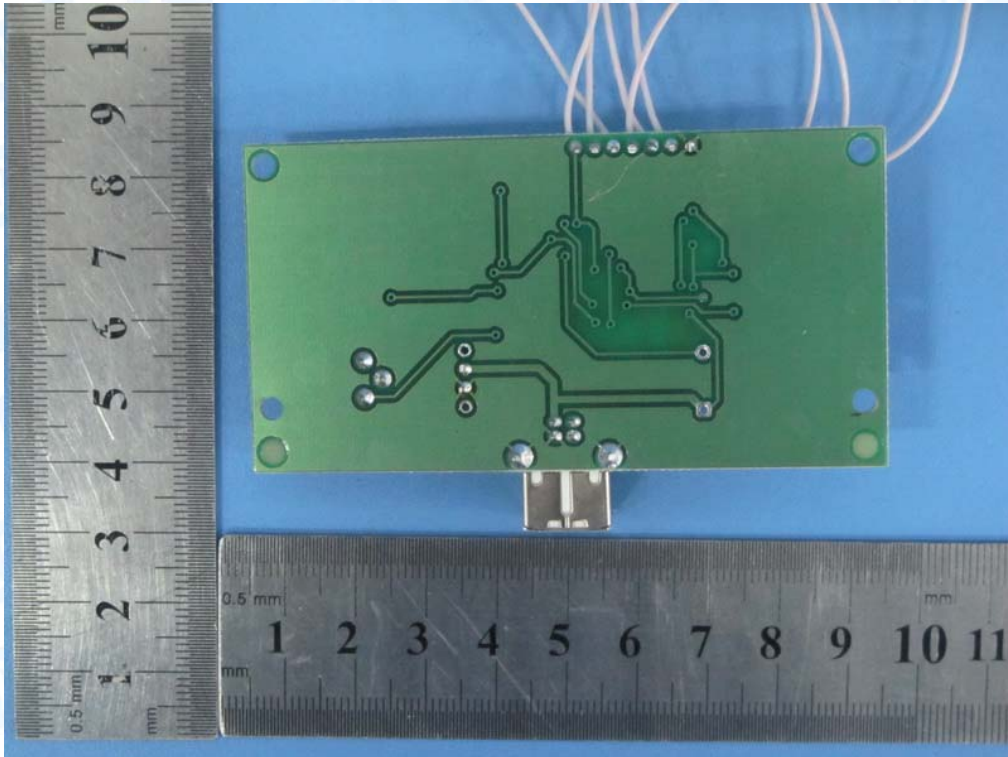



**Photo 5 Appearance of PCB**



**Photo 6 Appearance of PCB**





---

---

## 9. Photographs - Test Setup

Photo 1 Disturbance Power Test Setup



Photo 2 Radiated Emission Test Setup

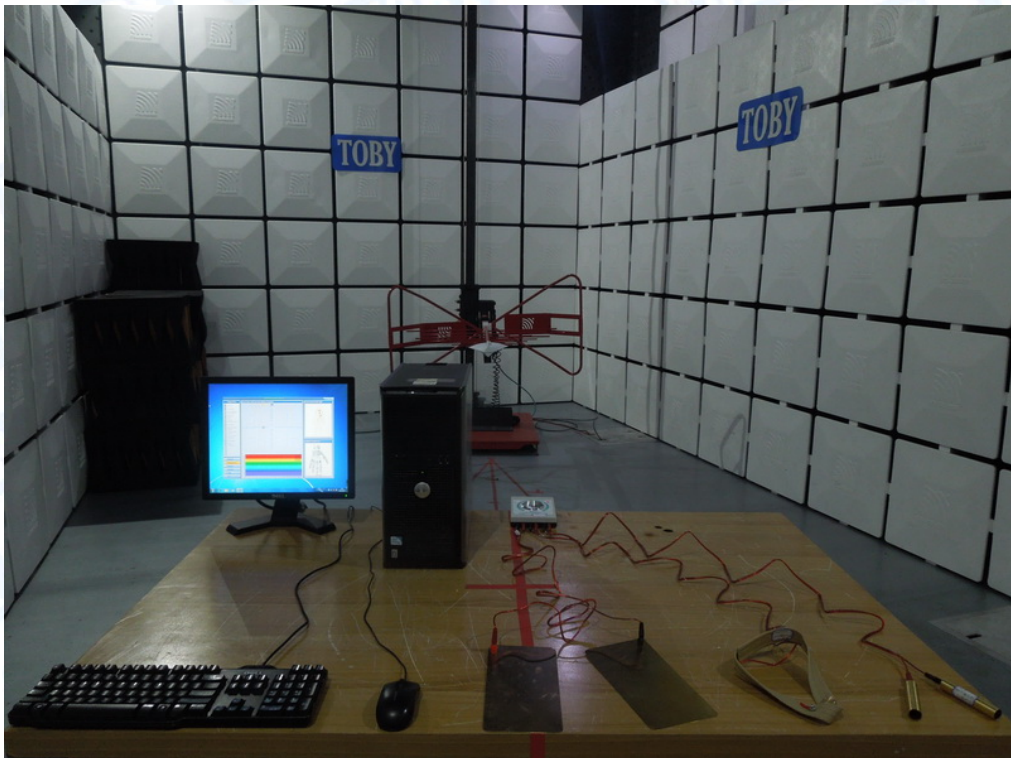



**Photo 3 Electrostatic Discharge Test Setup**

